

Hydraulic Unit

The hydraulic unit consists of a large oil reservoir, a multistage piston pump. The pump and auger run at a controlled speed and efficiency. Pump flow management maximizes output and minimizes pumping module wear.



The V-Ram pumps at the MBM Biosolids Pelletizing Facility in Stickney, IL are working well delivering wet-cake sludge to the dosing hoppers for the pelletizing operation. The pump's controls are easily integrated with MBM Biosolids' other equipment. V-Ram has been able to view the controls remotely and diagnose a problem in minutes, putting the facility back on line quickly.



V-Ram offers custom hoppers and silos to fit your application

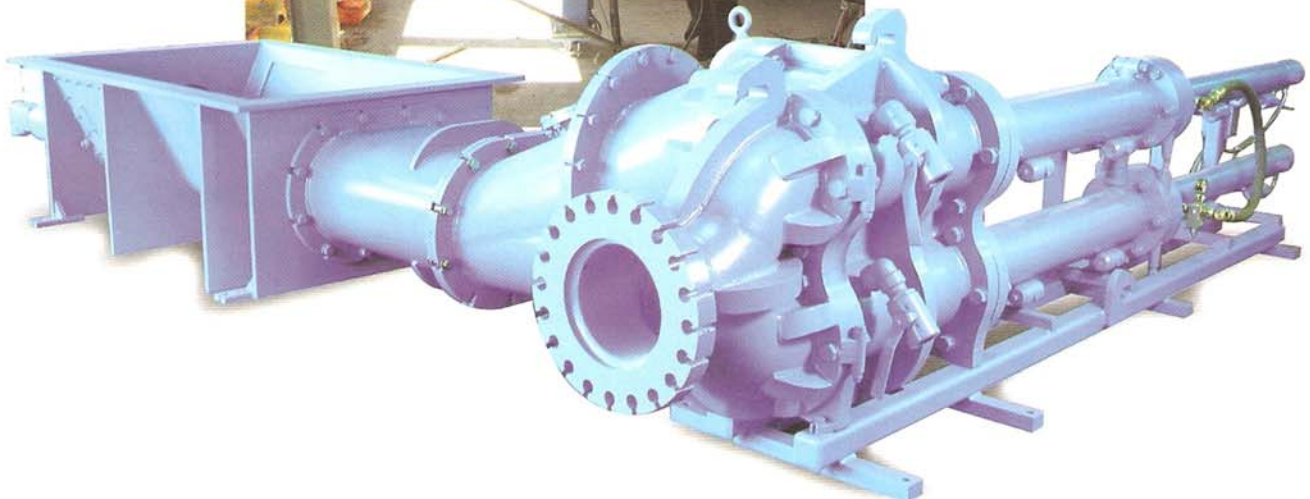

Controls

V-Ram controls consist of a PLC and PC operator interface which can be readily integrated into your system and is easily configured. Pumping volume can be controlled and compiled in several ways for EPA reporting. The control monitors pumping faults and informs the operator of proper corrective action.

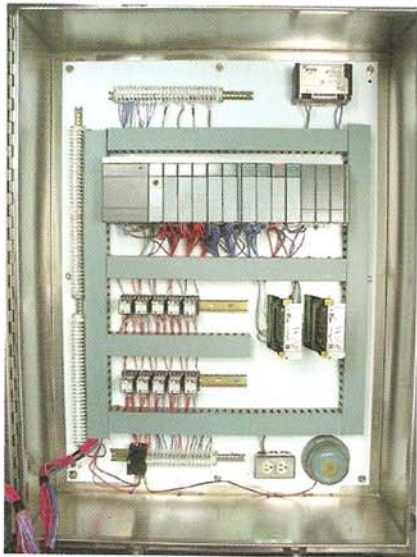

Let V-Ram help with your maintenance issues by trending pump operation metrics, such as pumping pressure, hydraulic pressure, fill points, auger speed and other diagnostic information. V-Ram has a 95% success rate analyzing and diagnosing issues without leaving the home office by connecting remotely to look at the trends of what the pump was doing when the problem occurred.



*Highly customizable,
PC-based control system
simplifies operations
and reporting*

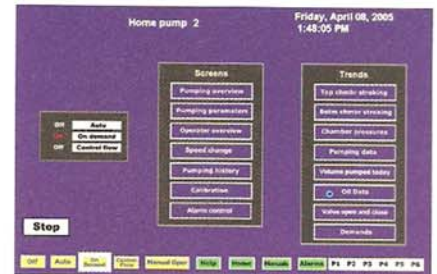
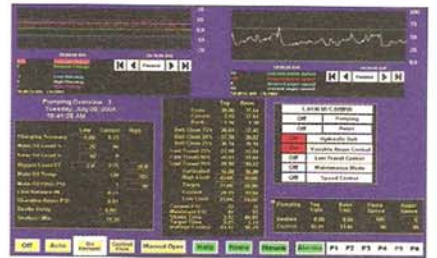
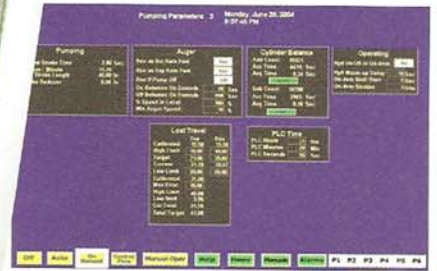

V-RAM
SOLIDS

620 South Broadway, PO Box 289
Albert Lea, Minnesota 56007
888-373-3996 F 507-373-5937
sales@vram.com

V-Ram has been in material handling since 1895.

Application Report: Sparks/Reno

Fall 2008



Truckee Meadows facility utilizing three V-Ram pumping systems

In 1993, V-Ram installed three “V”-shape pump modules at Truckee Meadows Water Reclamation Facility. After determining that the wear parts of “V”-shape model were no longer meeting their requirements, the facility changed to V-Ram’s 6DD Round Pump models in 2000. The three pumping systems deliver wet-cake to the truck loadout hoppers and include:

- Double 36” x 9” augers
- 45GPM / 30HP hydraulic units
- PLC controls

Maintenance Agreement

V-Ram provided a five-year maintenance agreement for a preset fee, which provided the City of Sparks a long-term budgeted cost for maintenance of the pump. This also provided opportunity for maintenance personnel to learn critical knowledge to be able to analyze and maintain the pump modules.

In the nine years of working with the 6DD pump modules in Sparks, V-Ram has a 95 percent success rate of analyzing the problem from V-Ram's Minnesota office. Most often, changes required either making a program change to keep the pump running or recommending to the maintenance personnel what to fix.

V-Ram is still assisting with online support. It has been reported to V-Ram that 80 percent of all repair work orders written on the dewatering system for repair were not related to the V-Ram pumps.

Maintenance contracts provide for planned budgeting of operating costs



V-Ram warranties Ball Valve System for 30,000 hours



Ball Check Valves:

1. Have a self-cleaning action for rags and other materials which would block other types of valves.

2. The effective wear surface of the ball valve is 50 times greater than that of poppet valves. The urethane wear life is ideal for this application.

3. Ball valve components are readily accessible through hinged sections of the pump head and can be replaced within two to three minutes after the pump is open.

Over 120,000 hours of operation pumping sludge at Truckee Meadows Water Reclamation Facility and there has not been a need to change ball valves or seats, ever — further evidence of the ball system's superiority to poppet valve systems.

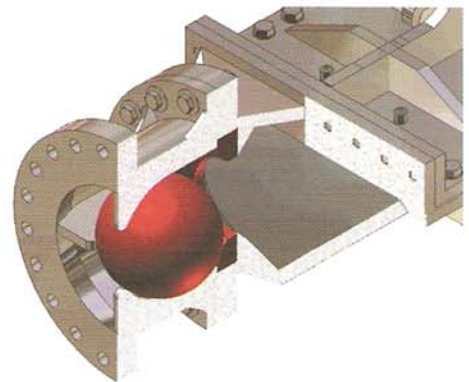

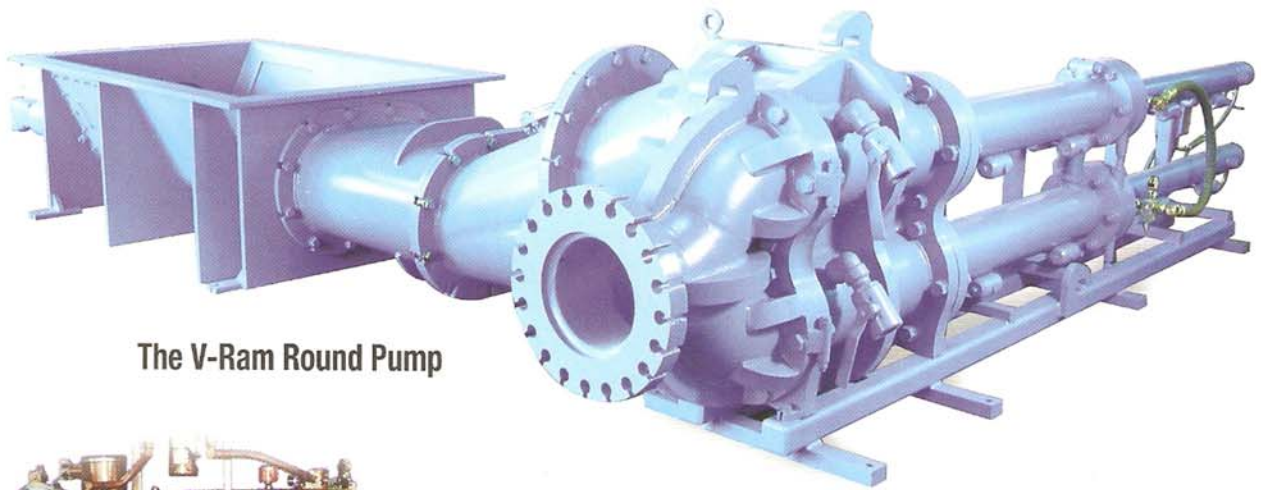

The V-Ram Round Pump

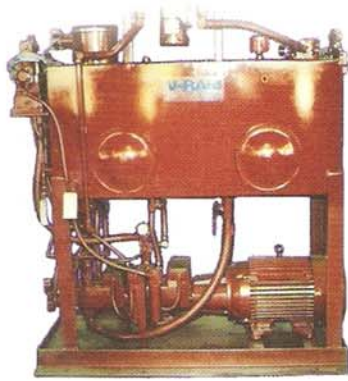

Hydraulic Unit

The hydraulic unit consists of a large oil reservoir for a multistage piston pump. The pump and auger run at a controlled speed and efficiency. Pump flow management maximizes output and minimizes pumping module wear.

V-Ram pumping piston advantage

With the V-Ram piston, instead of replacing the whole piston, the customer replaces only the worn seals. The seals are 20 percent of the cost of a complete piston and last two to five times longer than the typical Buna-N piston. Including the saved labor of replacement, V-Ram pistons average five percent of the maintenance cost of the typical Buna-N piston.

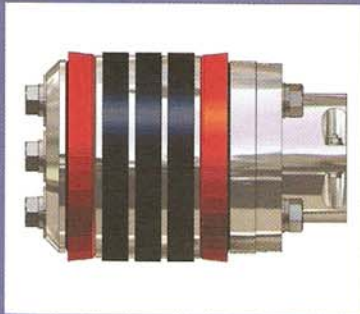

V-Ram cylinders have a linear transducer embedded in the center to control shifting and supply data to the PLC in order to make calculations needed to set volumes. The cylinders also have built-in supports for easy removal of the cylinder and piston for service or replacing.



Controls

V-Ram controls consist of a PLC and PC operator interface which can be readily integrated into your system and is easily configured. Pumping volume can be controlled and compiled in several ways for EPA reporting. The control monitors pumping faults and informs the operator of proper corrective action.

Let V-Ram help with your maintenance issues by trending pump operation metrics, such as pumping pressure, hydraulic pressure, fill points, auger speed and other diagnostic information. V-Ram is able to analyze and diagnose issues without leaving the home office by connecting remotely to look at the trends of what the pump was doing when a problem occurred.

*Highly customizable,
PC-based control system
simplifies operations
and reporting*

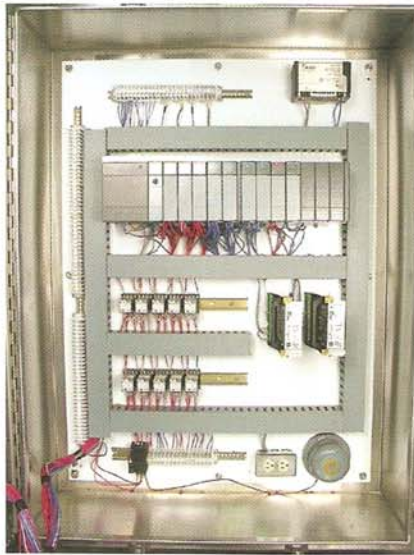

V-RAM
SOLIDS

620 South Broadway, PO Box 289
Albert Lea, Minnesota 56007
888-373-3996 F 507-373-5937
vram.com email: sales@vram.com

V-Ram has been in material handling since 1895.